

Article number: 03504070

Description: Fluro Rod end GE 70LO

Measures

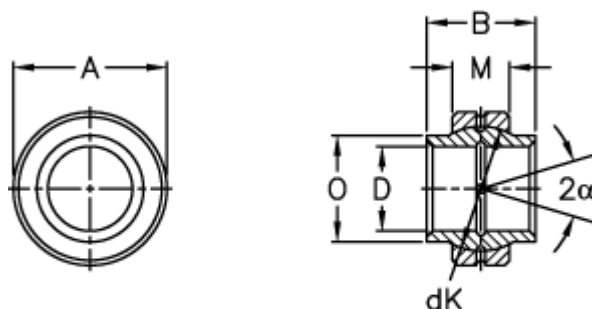

Str. 12 den smørerille

A	= 105 0 -0,015	Tilt angle = 4
B	= 70	Weight = 1600
D	= 70 0 +0,030	
dK	= 92	
Dynamic load C (kN)	= 315	
M	= 40	
O	= 79	
Static load C0 (kN)	= 1560	